



- Chair Mechanism
- Chair Base
- Chair Handle
- Cafeteria Frame
- Auditorium Chair Components
- Workstation Table Frame
- Table Legs
- Desk Frame





ABOUT US

We, "NSP ENTERPRISES" established in the year 2014 at Delhi is reckoned as one of the prominent manufacturers and suppliers of comprehensive range of sheet metal office chair components. With more than 30 years of expertise in sheet metal industry under the umbrella of " M/s Kala Engineer", our parent company , our effort is to deliver the best technological sheet metal solutions at par with the international standards.

A workforce of highly motivated, skilled personnel and professionally qualified staff in Design, Production, Planning, Quality control, Fabrication and Assembly are backbone of our company.

NSP Enterprises is very well equipped with the latest infrastructure and self-sufficient modern manufacturing facilities like in house nickel chrome plant, conveyORIZED powder coating plant, robotic welding, CNC laser cutting machine , CNC EDM wire cut machine, CNC pipe bending, NC sheet bending, pipe tapering, pipe chamfering, NC pipe cutting & sheet cutting with automatic feeding line for pneumatic power press to name a few with the latest technology for manufacturing, R&D and QC. We are continuously evolving our setup to be at par with best manufacturing facilities. The unique blend of modern technology from all over the world has enabled to maximize its capability.

All the basic parameters and assembly levels are maintained to serve the clients with the best quality products enabling them to achieve desired standard accuracies in their end products.

To achieve the best quality we have always arranged strict inspection and quality control in every process of our factory. From raw material sourcing, raw material inspection, half produced goods inspection and etc. we will try all our best to guarantee the best quality as per our customer.

We believe in "trust, quality and hands on service" as these are the key ingredients to establish solid business relationship with customer and maximize customer satisfaction. We sincerely look forward to establish a transparent credible and mutually profitable business relationship with you in the near future.

We are capable of meticulously customizing products based on requirements of customers.

Strength, Style & Sustainability - The Future of Metal Furniture Components.

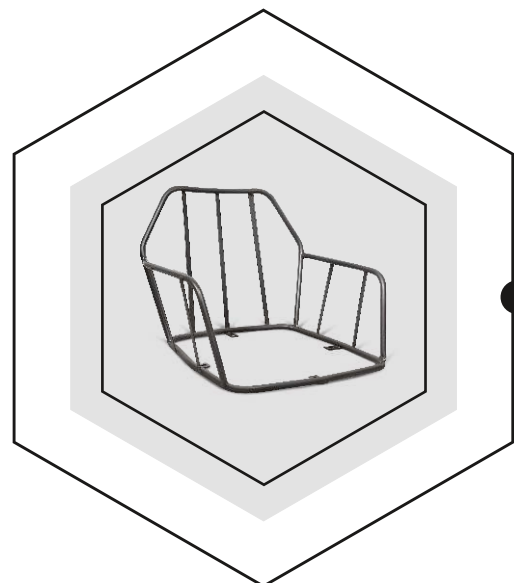
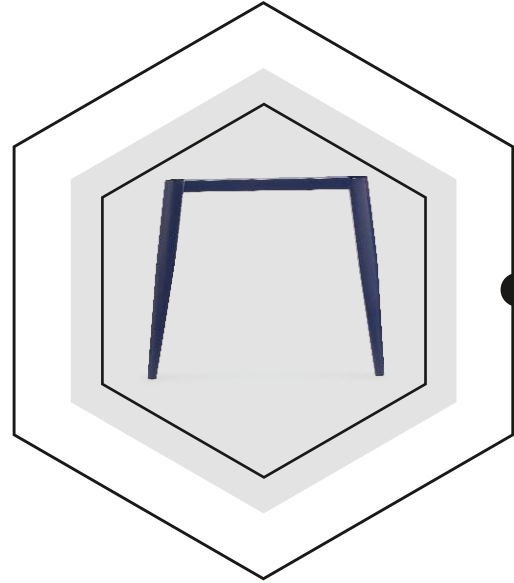
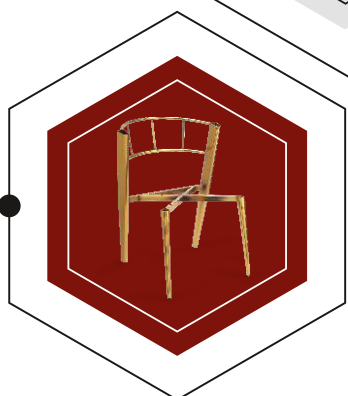
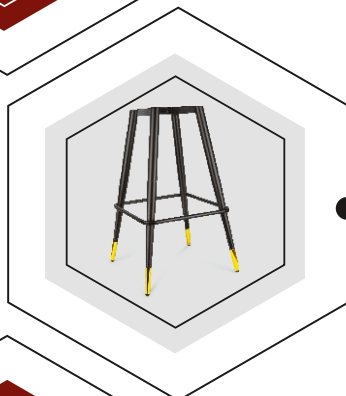
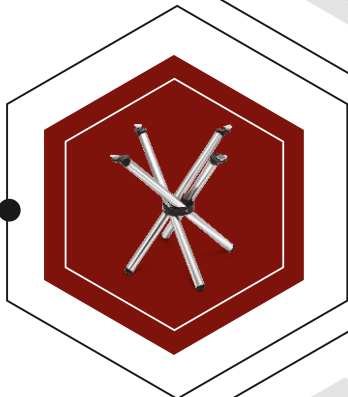
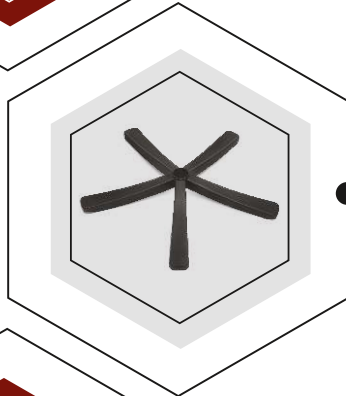
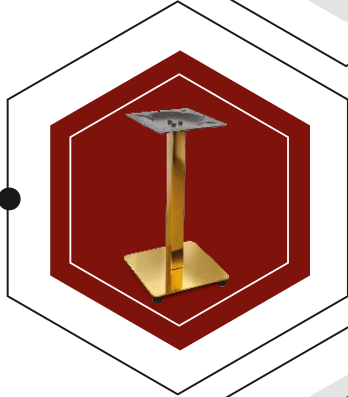
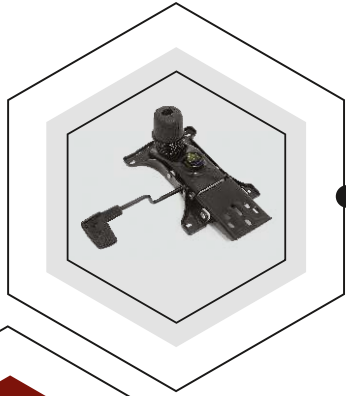

The Perfect Ergonomics
Superlative Designs....

TILTING MECHANISM

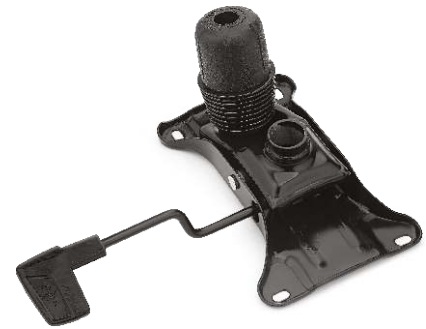

PUSH BACK MECHANISM



SLEEK PUSH BACK MECHANISM



USM-1
Sleek Push Back Mechanism



USM-2
Sleek Push Back Mechanism with Dibbi

SYNCHRO MECHANISM



USSM-1
Smart Synchro Mechanism



USSM-2
Big Synchro Mechanism

TORSION MECHANISM



UTRM-1
Torsion Mechanism



SPIDER BASE



UCB-101



UCB-102

WAVE BASE



UCB-103



UCB-104

FAN BASE



UCB-105



UCB-106

VISTA BASE



UCB-111

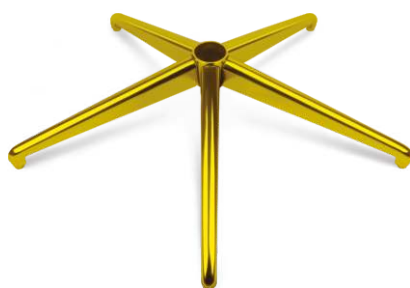

UCB-119



UCB-112

CHAIR BASE



STOOL BASE



UCB-113



UCB-114

FLAIR BASE



UCB-115



UCB-116

BEETA BASE



UCB-109



UCB-110

MONA BASE



UCB-120



UCB-121



UCB-122

ALFA BASE



UCB-107



UCB-108



UCB-117



UCB-118

AIR BASE



UCB-123



UCB-124

AERO BASE

BASE CAP



UBC-01



UBC-02



UBC-03



UBC-04

CHAIR HEIGHT ADJUSTER



Class 4

Size Available

- 65mm
- 85mm
- 100mm
- 120mm
- 140mm

SOFA BASE



USB-101



USB-102



USB-103



USB-106



USB-104



USB-107



Black with Gold Cap



Gold

UCAF-101



Rose Gold



Chrome



UCAF -101
Wooden



UCAF -113



UCAF -112



UCAF-108
Square Taper Pipe Frame

CAFETERIA FRAME



Black with Gold Cap

UCAF-105



Rose Gold



UCAF-104



UCAF-106

BAR STOOL FRAME



UCAF-109
Square Pipe Frame



UCAF-110
Square Pipe Frame



UCAF-111
D Pipe Frame



UCAF-103

With Gold Ring



UCAF-103 (Gold)



UCAF-107

TAPER PIPE



UTP-102

UTP-103

UTP-104

UTP-105

UTP-101



Forming Length- 450 mm
Diameter- 25mm to 75mm
Thickness- 2.5mm (max)

TABLE LEGS



UTL-101
(ALL SIZE AND COLOURS AVAILABLE)

UTL-102

UTL-103





UWTL-501 (Side Leg)



UWTL-502 (Side Leg)



UWTL-503 (2 Door Pedestal)



UWTL-504 (Riser)



UWTL-505 (Raceway)

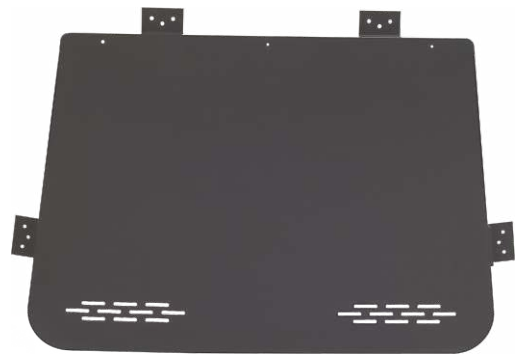

UWTL-506 (Leg Apron)



UWTL-507 (Front Modesty)



UWTL-508 (Connector)



UWTL-509 (Side Leg)



UWTL-510 (Side Leg)



UWTL-511 (Side Leg)



UWTL-512 (Side Leg)



UWTL-513 (Side Leg)



UWTL-514 (Side Leg)



UWTL-515 (Side Leg)



UWTL-516 (Side Leg)



UWTL-517 (Side Leg)



UWTL-518 (Side Leg)



UWTL-519 (Side Leg)



UWTL-520 (Side Leg)



UWTL-521 (Side Leg)



UWTL-522 (Side Leg)



UWTL-523 (Side Leg)



UWTL-524 (Side Leg)



UTF-102



UTF-103



UTF-104



UTF-105



UTF-106



UTF-107



UTF-108



UTF-109



UTF-101



UCAP-108
(BLACK, CHROME, GOLD, ROSE GOLD)



UCAP-109
(BLACK, CHROME, GOLD, ROSE GOLD)



UCAP-110

UCAP-111

(BLACK, CHROME, GOLD, ROSE GOLD)



UCAP-107



UCAP-106
Foot Ring (12", 15", 18")



UCAP-103 A
Big Cross Bar (M.S / S.S)



UCAP-101
4" Foot Rest (CH / PC)



UCAP-102
6" Foot Rest (CH / PC)



UCAP-103 B
Small Cross Bar (M.S / S.S)



UCF-112



UCF-113



UCF-105



UCF-101
S Chair Frame



UCF-104
S Chair Frame



UCF-114
S Chair Frame With Synchro Channel



UCF-115
S Chair Frame With Extra Support



UCF-107



UCF-111



UCF-106
Restaurant Stool Frame



UCF-109
Barfi Frame



UCF-103 A
Emerald Frame Black



UCF-103 B
Emerald Frame Chrome

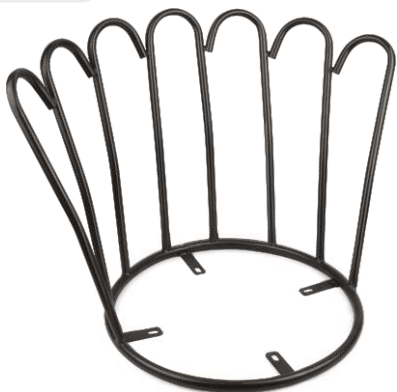

UCBF-201



UCBF-202



UCBF-203



UCBF-204



UCBF-205



UCBF-206



UCBF-207



UCBF-208

CAFÉ BACK FRAME



UCBF-209



UCBF-210

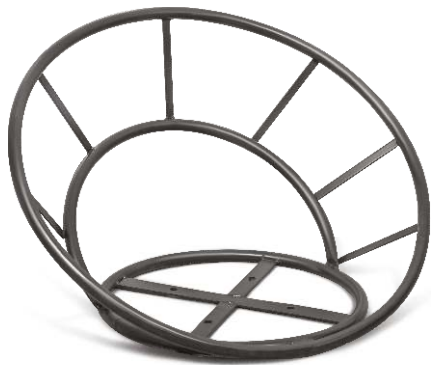

UCBF-211



UCBF-212



UCBF-213



UCBF-214

CHAIR BACK PATTA



UBP-101



UBP-102



UBP-103



UBP-104



UBP-105



UCH-029



UCH-030
Sleek Chrome

UCH-030
Sleek Black PC.



UCH-032



UCH-033



UCH-034

MESH BACK CHAIR FRAME



UMBF-101



UMBF-102

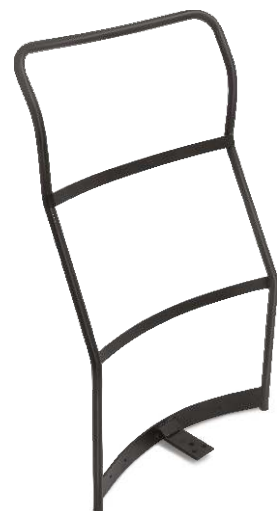

UMBF-103



UDF-1 (Double Seating)



UDF-2 (Double Seating)



UDF-3 (Single Seating)



UDF-4 (Single Seating)



USP-1
6" Square Plate



USP-2
4" Round Plate



USP-3
Megna Shell Fitting



USP-4
Z Patti



USP-5
Bush Patti (6mm)



USP-6
L Patti



USP-7
Study Table Fitting



USP-8
Back Patta Clamp



USP-9 A
Ply Patti W/O Bush (8mm)



USP-9 B
Ply Patti With Bush (8mm)



USP-10
Seat Patti



USP-11
Rotating Plate



A



B



C



D



E

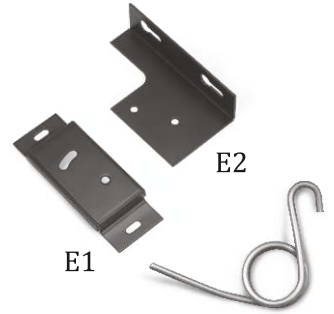

E1

E2

E3



F



G



H



I



J



K

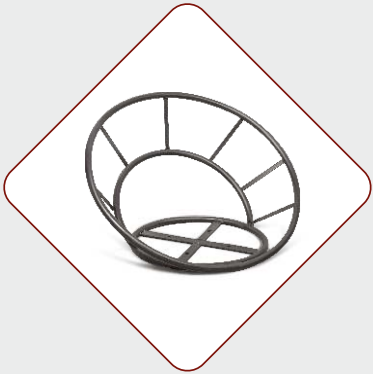

Website



Whatsapp

NSP ENTERPRISES

- 📍 Plot No.6, Block-O, Sector-1, DSIIIDC Industrial Area, Bawana, Delhi-110039
- 📞 +91-9810013908
- 🌐 www.unicoproductsindia.com
- ✉ info@unicoproductsindia.com